

Tefal®

 PDF LOW DEFINITION

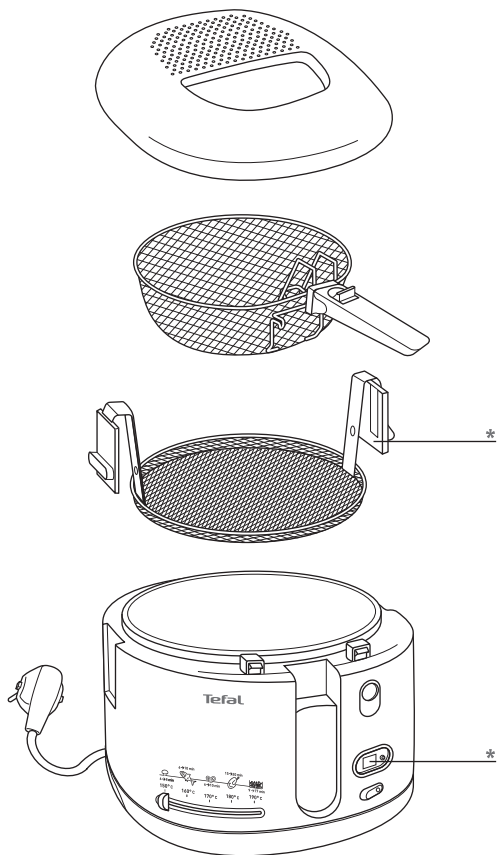

www.tefal.com



* Selon modèle • Afhankelijk van het model • Je nach Modell • Depending on model • Secondo i modelli • Según modelo • Consoante o modelo • ανάλογα με το μοντέλο • Modele göre • Áfhængig af model • Beroende på modell • Avhenger av modell • Mallista riippuen • Ovisno o modelu • Žavisno od modela • в зависимости от модели • Odvisno od modela • W zależności od typu • Podle modelu • V závislosti od modelu • Modelltól függően • В зависимости от модели • Залежно від моделі • Ovisno o modelu • Sõltuvalt mudelist • Atbilstoši modelim • Pagal modelį • بحسب الموديل • بر حسب مدل *

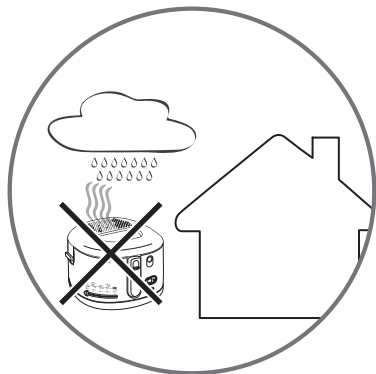

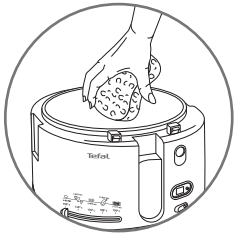
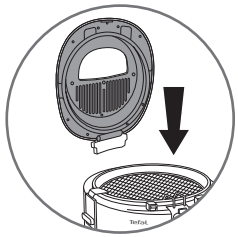
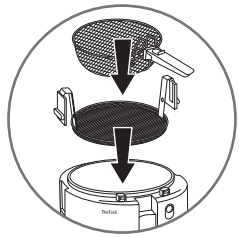
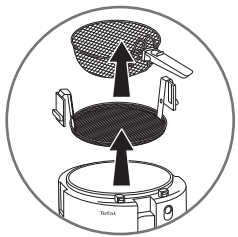
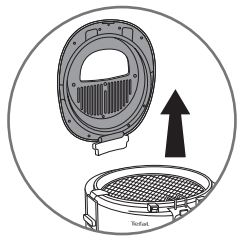
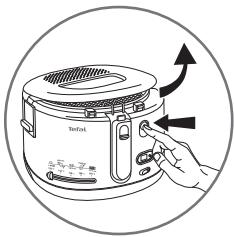



Min. 1,9 l
Max. 2,1 l

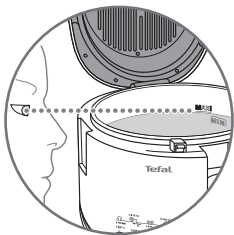
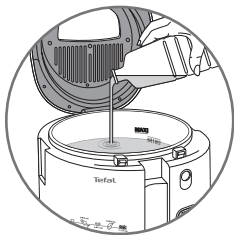

Min. 1660 g
Max. 1910 g

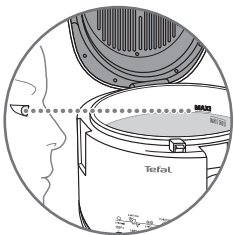
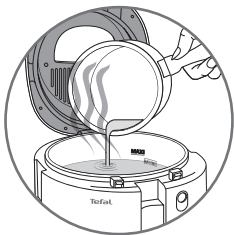
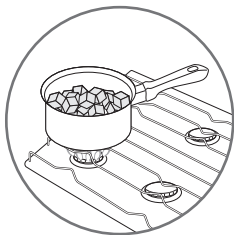



Max. 1200 g

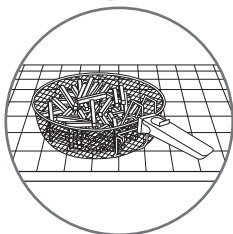
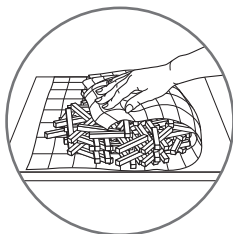

Max. 900 g

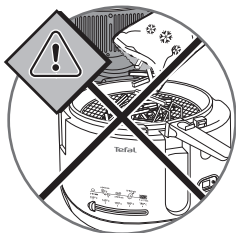
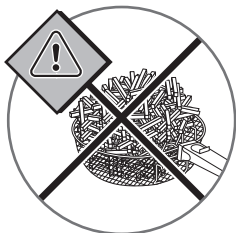
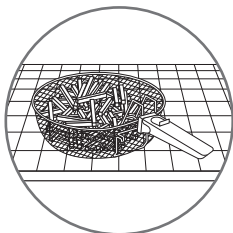
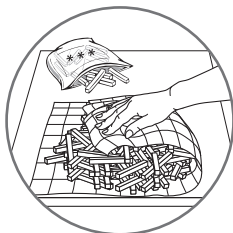

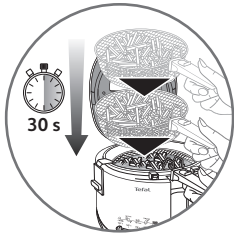
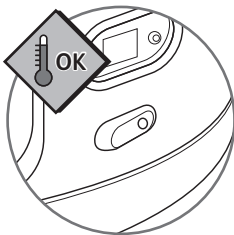
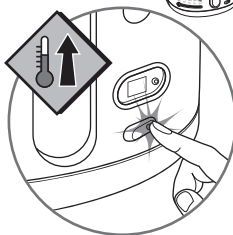
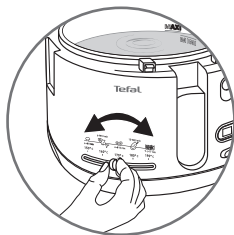
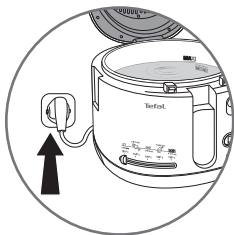

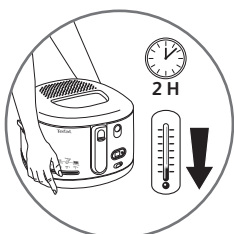
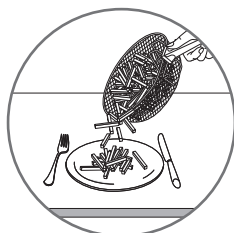
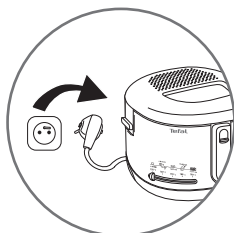
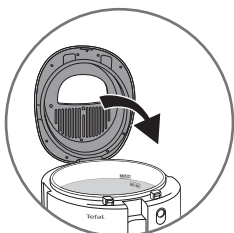
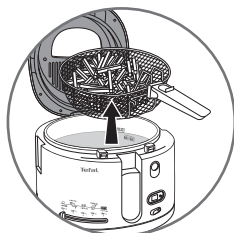
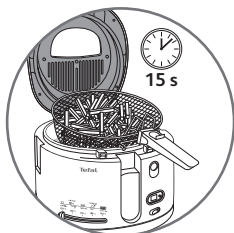
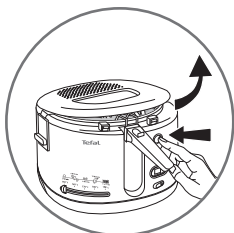
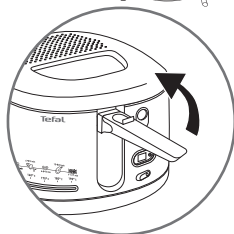
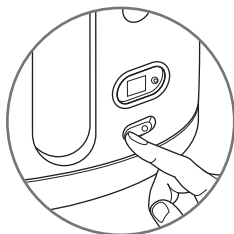
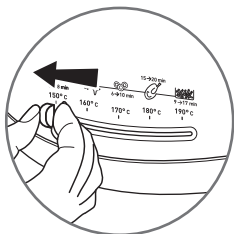

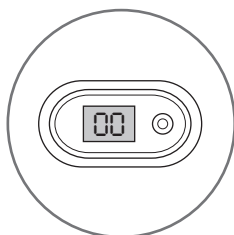
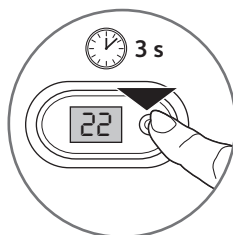
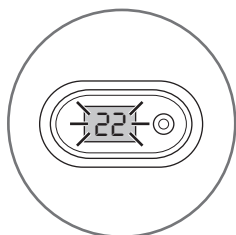
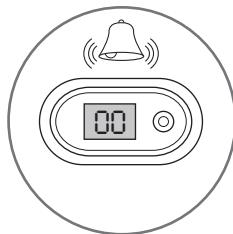
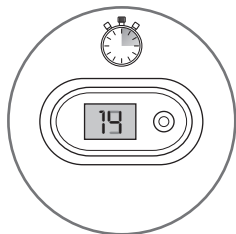
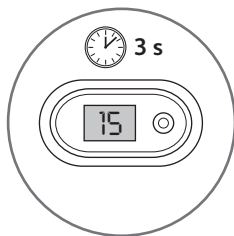
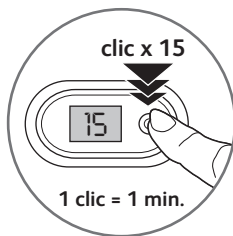
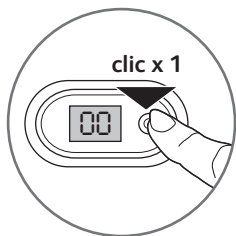



























* Selon modèle • Afhankelijk van het model • Je nach Modell • Depending on model • Secondo i modelli • Según modelo • Consoante o modelo • ανάλογα με το μοντέλο • Modelle göre • Áfhængig af model • Beroende på modell • Avhenger av modell • Mallista riippuen • Ovisno o modelu • Zavisno od modela • в зависимости от модели • Odvisno od modela • W zależności od typu • Podle modelu • V závislosti od modelu • Modelltól függően • В зависимости от модели • Залежно від моделі • Ovisno o modelu • Sõltuvalt mudelist • Atbilstoši modelim • Pagal modelį • بر حسب المدل • حسب الموديل



	Nb			
		600 g	170°C	+/- 11-13 min
		1000 g	190°C	+/- 14-16 min
		1200 g	1 170°C 2 190°C	+/- 6-8 min +/- 10-12 min
		350/400 g	190°C	+/- 6-7 min
	8		180°C	+/- 13-15 min
	3		170°C	+/- 6-8 min
		200 g	150°C	+/- 8-10 min
	7-8		180°C	+/- 8-10 min
	6		180°C	+/- 6-8 min
* * *	Nb			
		750 g	190°C	+/- 8-10 min
		450 g	170°C	+/- 8-10 min
	10		190°C	+/- 6-8 min
	8		190°C	+/- 13-15 min
		900 g	190°C	+/- 7-8 min
		300 g	190°C	+/- 5-6 min

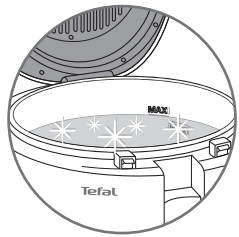
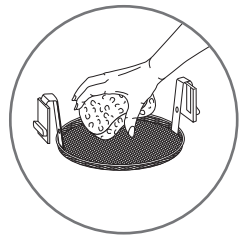
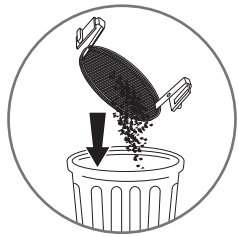

* Selon modèle • Afhankelijk van het model • Je nach Modell • Depending on model • Secondo i modelli • Según modelo • Consoante o modelo • ανάλογα με το μοντέλο • Modele göre • Áfhængig af model • Beroende på modell • Avhenger av modell • Mallista riippuen • Ovisno o modelu • Zavisno od modela • в зависимости от модели • Odvisno od modela • W zależności od typu • Podle modelu • V závislosti od modelu • Modelltól függően • В зависимости от модели • Залежно від моделі • Ovisno o modelu • Sõltuvalt mudelist • Atbilstoši modelim • Pagal modelį • بر حسب الموديل • بحسب مدل

